



# TRUCKRUN <sup>2024</sup> EBIKE SYSTEMS

Product manual

Drive System | Intelligent Drive | Accessories | Support

**TRUCK** RUN

# TRUCK RUN



## Motor Drives the World

Intelligent High-end Motor Leader

Drive Systems | Smart Cycling

# Contents

## **ABOUT TRUCKRUN**

Create eBike Drive Systems

2-3

---

## **SMART RIDING SOLUTION**

App and TRUCKRUN IoT Solution  
eBike Background Management Systems

4-5

---

## **CUSTOMIZED SOLUTION**

Meet the Multiple Complex Needs of Customers

6

---

## **RIDER-BIKE INTEGRATION SOLUTION**

Integrated, Small size, Big effect, Comfortable and Intelligent Riding

7

---

## **EBIKE DRIVE SYSTEMS**

Mountain, Fat tire, City, Road, Travel

8-17

---

## **TRUCKRUN MAIN MODELS**

Dedicated to You Our Proudest Work

18-23

---

## **LIST OF PRODUCT PARAMETERS**

Mid-Drive Motor, Hub Motor, Controller, Display and Sensor

24-32

---

## **FOLLOW TRUCKRUN**

Welcome to Our Official Website and Social Media

33

---

# ABOUT TRUCKRUN

Create eBike drive systems

TRUCKRUN was jointly established by experienced bicycle practitioners and enthusiasts. We poured our enthusiasm into the design of each product, and achieved technical self-research results in key core areas such as motor research and development, intelligent cycling, and Rider-Bike Integration. We insist on building our own intelligent manufacturing base as the only production model, and build our own supply chain system to ensure the high-quality supply of core components.

At present, our business covers more than 40 countries and regions around the world, covering various fields such as top competitive brands, overseas high-end brands and sharing platforms. In addition to eBike motors, TRUCKRUN also deploying electric motorcycles, electric boats, robots and other categories.

**30%**

Proportion of technicians

**15<sup>+</sup>**

Core team R&D experience

**50<sup>+</sup>**

Chinese, United States and Japanese patents



**TRUCKRUN**

## INTELLIGENT HIGH-END MOTOR LEADER

The vision of "committed to becoming a leader in intelligent high-end motors" is driving us to continuously pursue the ultimate products and efficiency. We invest a lot of energy in research and development, and the proportion of technical personnel reaches 30%, the core team has more than 15 years of experience. TRUCKRUN stands out through continuous technological breakthroughs and innovations, such as the industry-leading ultra high-torque mid drive motor M09, the powerful and versatile mid drive motor M03, and the High-strength quick-release barrel shaft motor RN04 etc, which have achieved a continuous miracle TRUCKRUN.



“Motor Drives the World” is the mission of TRUCKRUN Motor, we are committed to creating a more efficient, smarter and more comfortable eBike drive system for people.

## SMART RIDING

We believe that ebike is not only a means of transportation, but also a way of life that represents the future, so we created the TRUCKRUN IOT Solution™. It connects bicycles, APPs, drive units, control units, and displays with each other through Bluetooth and cellular data networks. Riders can enjoy more riding fun through it, and eBike companies can use it to upgrade services and establish close ties with consumers.

## RIDER-BIKE INTEGRATION

TRUCKRUN is committed to bringing users a good riding experience of "integration of rider and bike". We focus on this point at the beginning of product design, and constantly optimize products based on massive test data. At present, more than 95% of TRUCKRUN hub motors can be equipped with tower base torque, and the mid drive motor is fully integrated with the center axis torque sensor, making your eBike more intelligent, comfortable and agile.

# SMART RIDING SOLUTION

eBike is not only a means of transportation, but also a way of life that represents the future

We believe that eBike is not only a means of transportation, but also a way of life that represents the future. For this reason, we developed the TRUCKRUN APP and created the TRUCKRUN IOT Solution™. They connect bicycles, APPs, drive units, control units, and displays with each other through Bluetooth and cellular data networks. Riders can enjoy more riding fun through it, and eBike companies can use it to upgrade services and establish a close relationship with consumers.

## 01 App & TRUCKRUN IOT Solution™

Let the rider enjoy more fun

### ■ Simple Model

Only need a Bluetooth display or other Bluetooth modules to use

Your eBike can communicate with the APP to form information interaction through any Bluetooth-enabled device, and riders can enjoy many intelligent control functions on the mobile phone.



#### Virtual code table

After the connection, the APP can display a very rich vehicle information. Compared with the display (LED & broken code), the information displayed by the APP is more abundant



#### Riding Information

Can query riding data and riding track



#### System firmware update

Through the APP forward function, the eBike can be kept up to date at any time



#### Parameter settings

It can meet the individual needs of riders, and the eBike parameters can be set in detail according to the needs to adapt to different road conditions



#### Navigation function

The APP can be connected with third-party map software, such as Google Maps, to call data for navigation and plan cycling routes. With TRUCKRUN bluetooth color screen display such as CC03, CC05, you can also perform path projection on the display screen to easily find the cycling route



IOT (IOS)



IOT (Android)

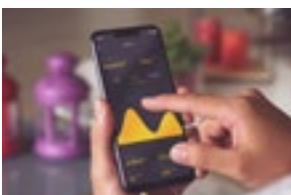

## Advanced Model

Through TRUCKRUN IOT Solution™ Enjoy a digital cycling life

With the IOT-enabled display screen, your ebike can form information interaction with the APP through the cellular network. TRUCKRUN IOT Solution™ can support all functions of the simple mode and realize more advanced functions



### Remote monitoring

The APP and IOT communicate through the 4G network, even if the person and the vehicle are separated, you can easily control the vehicle status and monitor the status of the vehicle in real time



### Intelligent anti-theft

Precisely locate the vehicle, you can set the alarm, once the vehicle is moved, the alarm will notify the owner to prevent the vehicle from being stolen

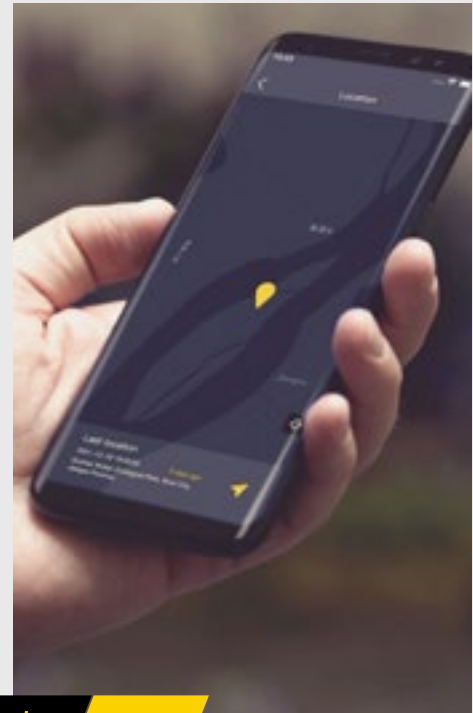

Truckrun IOT Solution

## 02 eBike background management system

Upgrade services and establish a close relationship with consumers



### Improve user experience

Global active time analysis, regional activity analysis for targeted events, targeted outlets for news push, and product firmware upgrades for users



### Promoting products

Publish product promotion information through the background to let customers know about the latest products and promotional activities



### Operations Management

Electronic fence can be set up to remind riders beyond the area



# CUSTOMIZED SOLUTION

Meet the multiple complex needs of customers

We have a professional R&D design system, perfect quality control capabilities and mass production capabilities, providing customized drive system solutions for eBike, including motor design, controller systems, etc. The intelligent production capacity with high automation and full process traceability can meet the multiple and complex needs of customers.

## 01 Performance customization

We have the industry's top R&D and design capabilities, and can realize the ideas of our partners in terms of power, torque, lightweight design, response speed, running sound, etc. according to the demands.

## 02 Function customization

We have developed a powerful ebike management system, the OTA function keeps the eBike driving system up to date, and the vehicle management system helps store operations and activities. There are many other features waiting for you to explore.

## 03 Appearance customization

We meet customers' customized needs for product appearance through professional design and craftsmanship. Whether it is size or appearance style, it is guaranteed to meet the ID design of eBike.



# CUSTOMIZTION



# RIDER-BIKE INTEGRATION SOLUTION

Excellent alternative to center shaft torque sensor

## 2 Reason to choose TRUCKRUN Built-in Cassette Torque Sensor



### Easy to install and maintain

Integrated, small size, big effect, comfortable and smart riding. No need for special Bottom Bracket, easy to install and maintain, reduce after-sales annoyance.



### Functionality equivalent to a center shaft torque sensor, but in a more compact form

Just like a center shaft torque sensor, the TRUCKRUN Built-in Cassette Torque Sensor can quickly adjust the motor's power output based on the force applied, making the bicycle more responsive and significantly enhancing the riding experience.



### Read More

More detailed diagrams and explanations.



# MOUNTAIN BIKE

## Zenith Series

Zenith Series (Pinnacle Series) Designed for cyclists who want to conquer the mountains. When facing steep hills, rough terrain, the TRUCKRUN mountain drive system can provide powerful power and let you regain acceleration after thrilling turns

**13%**

**Did you know?**

A large number of TRUCKRUN products adopt modular design, such as M01, M03, M06, etc., which not only facilitates installation and maintenance, but also reduces the overall cost. In addition, we have China's first-class supply chain management level and adopt an industry-leading cost control system, which makes the average cost of TRUCKRUN more than 13% lower than the peers.



## Zenith Series M03 Edition

Compact and powerful, help you concentrate on exploring unknown peaks



### M03

Strong power: rated power 350W-500W, maximum torque up to 140N.m  
ISIS Shaft (Optional): Responsive, powerful, sprag clutch for quiet and smooth operation



### CC08

1.96 inch TFT color screen  
Compact design for mountain environments  
type-c Charging function  
Walk function



## Zenith Series M09 Edition

Specially designed for mountain enthusiasts, powerful and intelligent, mountain legend



### M09

Power performance: rated power 750W, maximum torque up to 150N.m  
ISIS Shaft (Optional): Responsive and Powerful  
Efficient heat dissipation: streamlined wind resistance heat dissipation ribs, efficient heat dissipation, stable and durable



### CC03

3.5-inch central TFT color screen type-c charging function  
Auto Sensing headlights, Walk function  
Bluetooth function, navigation mapping



## Zenith Series RW28 Edition

High-power hub MTB drive system



### RW28

Strong power: rated power 750W, maximum torque up to 70N.m  
Sensitive Response: It can integrate the torque of the cassette, sensitively perceive the needs of the rider, and adjust the output power in a timely manner



### CB01-X

3.5-inch central LCD dot matrix screen  
USB charging function  
Auto Sensing headlights  
Walk function

# FAT-TIRE BIKE/ CARGO

## Maverick Series

Maverick Series advanced drive system adopts industry-leading high-torque motors to provide you with powerful assistance, easy traverse various complex terrains, and transport heavy goods smoothly.

Good mechanical structure and heat dissipation system, continuous and stable output power, avoiding overload and other problems caused by high power, efficient and reliable.



### 220

#### Did you know?

The maximum torque of the M09 motor designed by TRUCKRUN motor has reached more than 220N.m, which means that our products are at the leading level in the world. This is due to TRUCKRUN's great emphasis on innovation and unremitting pursuit of cutting-edge technology. We invest a lot of money in research and development every year, and the technical team accounts for 30%. Many core team members have more than 15 years of work experience.

## Maverick Series M09 Edition

Smooth all-terrain, the strongest drive system of TRUCKRUN so far



### M09

Strong power: rated power 750-1200W, maximum torque up to 220N.m  
ISIS Shaft (Optional): Responsive and Powerful  
Efficient heat dissipation: streamlined wind resistance heat dissipation ribs, efficient heat dissipation, stable and durable



### CC05

3.5 inch central horizontal screen TFT color screen  
type-c charging function  
Auto Sensing headlights, walk function  
Optional Bluetooth, IOT, navigation mapping function



## Maverick Series Dual Drive Edition

Dual drive fat tire system



### FW29+RW29

Strong power: maximum torque (90\*2) N. m  
Power (1000/1200/1500W) \*2  
Quick response: Axis speed sensor, sensitive to the needs of riders



### CB03

1.6-inch left LCD break code screen  
walk function  
Battery status monitoring

Fat tire/ Cargo  
Maverick Series



2024  
TRUCKRUN  
E-bike System

# CITY BIKE

## Urbanite Series

The driving system of TRUCKRUN City Bike is keenly aware of the needs of riders, and adjusts the output power in time to allow you to travel more smoothly in the city. TRUCKRUN Urbanite Series city bike kit will provide your electric bicycle with a comfortable, quiet and stable riding experience, helping your product better adapt to the needs of urban travel.



**50**

**Did you know?**

TRUCKRUN pays attention to product innovation and compliance, and has applied for more than 50 patents in the United States, Japan and China.

The full range of products meet the environmental protection directives or certifications required by various national and local regulations and governments.

And incorporated into the quality management system. Including but not limited to European Commission directive conformity verification, EN15194 standard, EU electric bicycle ROHS, CE certification and UL certification, etc.

## Urbanite Series M03 Edition

Riding Comfortable and powerful



### M03

ISIS Shaft (Optional): Responsive, Powerful  
Quiet and stable: sprag clutch ensures quiet and smooth operation



### CB01-X

3.5-inch central LCD dot matrix screen  
USB charging function  
Auto Sensing headlights  
Walk function

## Urbanite Series M06 Edition

Simple and pure, cost-effective, modular design and easy maintenance



### M06

Strong power: rated power 250W, maximum torque up to 95N. m  
Modular design: easy to install and maintain



### CB03

1.6-inch left LCD break code screen  
walk function  
Battery status monitoring

City Bike  
Urbanite Series



2024  
TRUCKRUN  
E-bike System

# ROAD BIKE

## Aurora Series

The drive system of TRUCKRUN road bikes has been carefully developed to ensure that riders can enjoy a quiet, comfortable and stable riding experience. It is keenly aware of the subtle changes in the rider's thoughts, and adjusts the output power in a timely manner, allowing you to easily control the road and shuttle smoothly on the road.

**3**

**Did you know?**

TRUCKRUN's three major product design concepts: simple and elegant, excellent performance, smart and easy to use.



**Truckrun** IOT Solution



## Aurora Series RN04 Edition

Quick release structure, high speed, sensitive response, simple appearance



### RN04

Power: rated power 250W, maximum torque 28N.m

Lightweight: weight 2.0KG

Quiet: high-strength thru axle design < 55 decibels

Quick release: quick wheel change



### E03

LED display

Auto Sensing headlights

Walk function

TRUCKRUN IOT

**Truckrun** IOT Solution



## Aurora Series RN02 Edition

High torque, responsive, simple appearance



### RN02-C

Power: rated power 250W, maximum torque 38N.m

Sensitive: Integrate cassette torque, keenly perceive the needs of the rider, and adjust the output power in a timely manner

Lightweight: weighs only 2.1KG

Quiet: high-strength barrel shaft design < 55 decibels



### E03

LED display

Auto Sensing headlights

Walk function

TRUCKRUN IOT

Road Bike  
Aurora Series



2024  
TRUCKRUN  
E-bike System

# M03

Balanced  
Performance  
Excellent Upgrade



## Balanced Performance Excellent Upgrade

M03 is a brand new upgraded version of the classic motor M01, it is an excellent upgraded product.

The power of the M03 motor can be configured from 250 to 500W, which is suitable for various scenes such as cities, roads, touring, mountains, beaches, and snow, and has a maximum torque of up to 140N.m. This means that it has stronger power output and excellent climbing ability, and is more stable and reliable in environments such as snow or soft sand.

## Comfortable Riding

M03 also has a built-in high-sensitivity torque sensor and a high-strength ISIS center shaft, which can accurately measure the rider's power output during riding, and feed this information back to the motor controller to control the output of the motor, providing better explosive power and accelerate performance.

Whether it's on tricky off-road trails or your daily commute, the M03 delivers exceptional performance and riding experience.

## Quiet and Soft

A sprag clutch is used instead of a ratchet clutch, which makes the return angle of the bottom bracket close to about 0 degrees, resulting in a softer ride. In addition, the sprag clutch further reduces the noise of the motor and improves riding comfort.



# M09

the most powerful ebike motor of TRUCKRUN Motor so far



## Super power, Designed for All Kinds of Off-road Terrain.

M09 is the most powerful ebike motor of TRUCKRUN Motor so far. It has multiple power options of 1200/1000/750W, and the maximum torque is up to 220N.m. It makes your E-mountain bike easy to climb steep hills, and let the ebike move freely in the sand and snow.

## Streamlined Appearance Design, Stable and Long-lasting Operation

While providing powerful power, the M09 adopts a special streamlined design that allows heat to be dissipated in time and ensures the motor can run stably for a long time.

## Comfortable Experience, Flexible Response to Various Situations

The built-in high-sensitivity torque sensor can be equipped with an ISIS shaft, which can sense changes in pedaling force at any time and adjust the power output to bring a comfortable riding experience to the rider.



# RW28

High power  
Mountain hub  
motor



## Designed for Mountains

RW28 is a high-power hub motor specially designed by TRUCKRUN for E-mountain bikes, with a rated power of 750W and a maximum torque of 70N.m.

## Smooth Riding Experience

The optional high-sensitivity torque sensor can achieve a natural and smooth riding experience while extending battery life.



# RW11

High power fat tire  
bike hub motor



## Specially Designed by TRUCKRUN for Fat Tires

RW11 is a lightweight and high-power hub motor specially designed by TRUCKRUN for fat tires. It can help vehicle factory control the costs, and the maximum torque is up to 80N.m, so that more people can enjoy the joy of riding on the beach and snow.



# M06

Modular design  
Enjoy the simple  
life



## Specially Designed for Urban Environments, Sensitive to Various Situations

The built-in high-sensitivity torque sensor can sense the change of pedaling force at any time, adjust the power output, and bring a comfortable riding experience to the rider.

## Easy and Simple Maintenance Experience

Modular design, the controller adopts external assembly method, which is convenient and fast for installation and maintenance.



## High Cost Performance, Let More People Experience the Joy of EBike

Thanks to the excellent integrated design, M06 saves manufacturing costs, making it cheaper than motors with the same power, and consumers can get excellent experience with less money.



# RN04

Quiet, powerful,  
High strength  
quick removal  
Thru Axle



## Light and Fast, Enjoy the Thrill of Riding

TRUCKRUN RN04 is specially made for high-end road bikes, it weighs only 2.0KG and contains powerful energy. 250W of power bursts out to a top speed of 420 ( $\pm 10$ ) with less than 55 dB of noise. Let your ebike easily get rid of the shackles and help you enjoy the thrill of riding.

## High-strength Thru Axle, Stable and Durable

RN04 adopts an industry-leading Thru Axle design, which is stronger than traditional hub motors. After the salt spray test, the performance broke through 96 hours. The waterproof level reaches IPX5 level, the efficiency is  $\geq 80\%$ , and the performance is stable and long-lasting.

## Quick Disassembly Function, No Fear of Emergencies

The RN04 is equipped with a quick disassembly function, allowing you to handle any unexpected situation, while also meeting the needs of enthusiasts.



## M11/M12

M11: Compact and Concealed.

M12: Compatibility and Powerful.

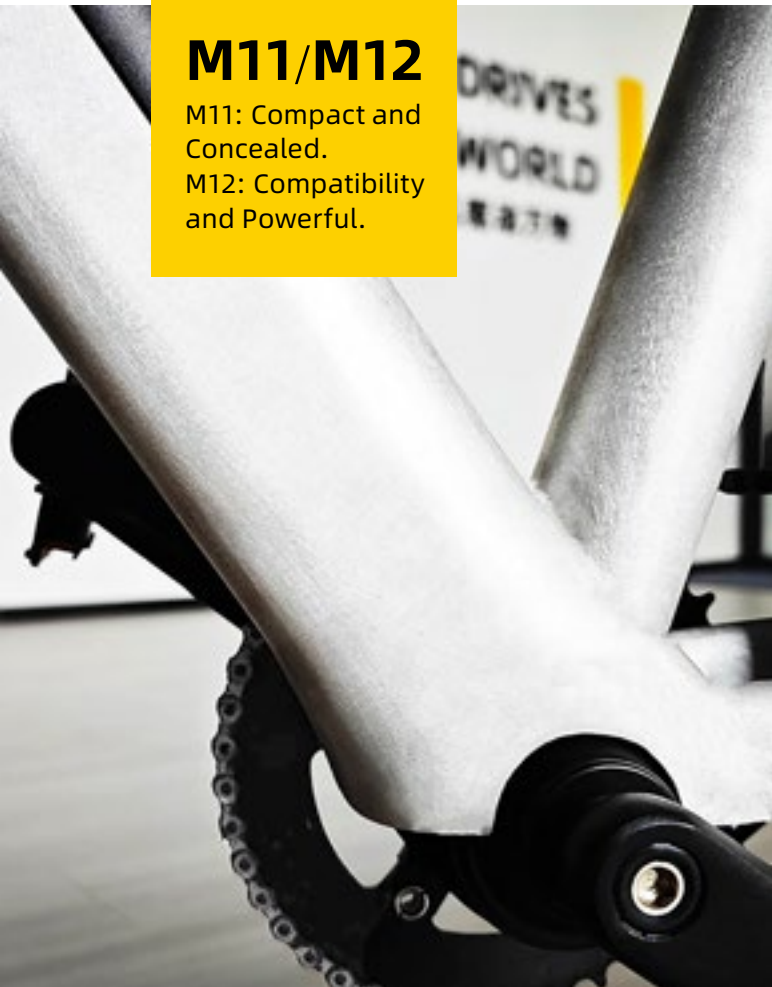

### M11: Compact, Discreet, and Lightweight

The M11 motor stands out as an excellent choice for electric bicycles due to its compact, discreet, and lightweight features. This motor can almost completely conceal itself within the bicycle frame's down tube, weighing a mere 1.9 kilograms. Simultaneously, it operates exceptionally quietly, preserving both the traditional appearance of the bicycle and the serenity of the riding experience. Furthermore, the M11 motor provides riders with assistance of up to 60N.m, offering them precisely the right level of support. As a mid-drive motor, it also ensures a balanced distribution of weight across the entire bicycle, guaranteeing stable riding performance.



**NEW**

### M12: Compatibility and Powerful

M12 is compatible with mainstream bracket hangers on the market, eliminating the need for additional design, thus saving costs for you. Meanwhile, this motor, carefully designed by us, offers superior power at a lighter weight (3.6kg/3.9kg), with the 750W version delivering a maximum torque of up to 160N.m.



**NEW**



# THE NEWEST MOTOR





**M11**



**M12**

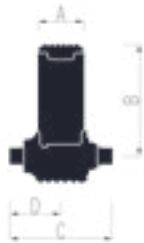
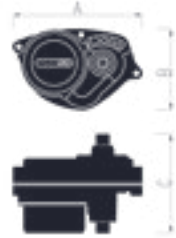

**M03**

OVERVIEW	Compact and Concealed	Compatibility and Powerful	Excellent Upgrade
SUITABLE MODEL	City/Road/Trekking	MTB/All-Terrain	City/Trekking/MTB
POSITION	Mid Motor	Mid Motor	Mid Motor
DIMENSION			
A (mm)	60	192	202
B (mm)	149	128	135.5
C (mm)	135	153.5	153
D(mm)	67.4	-	-
Start-up behaviour	harmonious agile	powerful	sporty
PARAMETER			
Rated Voltage(Vdc)	36	48	36-48
Rated Power (W)	250	500/750	250/350/500
Rated Speed(Rpm)	100-120	90-100	100/100/115
Maximum Torque(N.m)	60	120/160	100/120/140
Shaft Type	ISIS	ISIS	JIS/ISIS
Weight (kg)	1.9	3.6/3.9	3.3/3.6/3.8
Efficiency (%)	≥ 80	≥ 80	≥ 80
FUNCTION			
Power Off Brake	Optional	Optional	Optional
Handlebar Throttle	Optional	Optional	Optional
Lights Voltage (V/W)	6V3W	6V3W	6V3W
Walk Assist Function	Optional	Optional	Optional
Gear Sensor	Optional	Yes	Optional
Noise (dB)	< 55	< 55	< 55
IP Level	IPX6	IPX6	IPX6
Operating Temperature(°C)	-20~55	-20~55	-20~55



TRUCKRUN's products have passed EN15194, ROHS, CE and UL tests and certifications.

# MID-DRIVE MOTOR





**M01**



**M06**



**M09**

OVERVIEW	Strength Classic	Simple Life	Super Performance
SUITABLE MODEL	City/Road/Trekking	City	MTB/Fat-tire
POSITION	Mid Motor	Mid Motor	Mid Motor
DIMENSION			
A (mm)	205	220	233
B (mm)	135.5	148	144.5
C (mm)	153	153.5	163
Start-up behaviour	sporty	harmonious agile	powerful
PARAMETER			
Rated Voltage(Vdc)	36-48	36	48-60
Rated Power (W)	250/350/500	250	750/1000/1200
Rated Speed(Rpm)	100/100/115	90	120/135/160
Maximum Torque(N.m)	100/120/140	95	150/200/220
Shaft Type	JIS	JIS	JIS/ISIS
Weight (kg)	3.3/3.6/3.8	3.4	5.8/6.0
Efficiency (%)	≥ 80	≥ 80	≥ 80
FUNCTION			
Power Off Brake	Optional	Optional	Optional
Handlebar Throttle	Optional	Optional	Optional
Lights Voltage (V/W)	6V3W	6V3W	6V3W
Walk Assist Function	Optional	Optional	Optional
Gear Sensor	Optional	Optional	Yes
Noise (dB)	< 55	< 60	< 60
IP Level	IPX6	IPX6	IPX6
Operating Temperature (°C)	-20~55	-20~55	-20~55



TRUCKRUN's products have passed EN15194, ROHS, CE and UL tests and certifications.

# HUB MOTOR



**FN01**



**RN02**



**RN04**



**RW01-L**

<b>POSITION</b>	Front	Rear	Rear	Rear
<b>SUITABLE MODEL</b>	City/Road	City/Road	City/Road	City/Road
<b>DIMENSION</b>				
Integrated wheel	Optional	-	-	-
A (mm)	42.5	40	36.6	39.5
B (mm)	φ105	φ121.7	φ125.5	φ140.8
C (mm)	φ44	φ44	φ60	φ44
D (mm)	10.5	15.25	15.25	15.25
E (mm)	2.5	19.6	43.7	38.5
OLD (mm)	100	100/130/142	142	100/135/142
Wheel Diameter (Inch)	20-29	20-29	20-29	20-29
Installation Mode	-	All Fit	Cassette	All Fit
Spoke Size	12G-13G/28H	12G-13G/36H	12G-13G/28H	12G-13G/36H
Cabling Route	Shaft Side	Shaft Side/Shaft End	Thru Axle/Shaft Side	Shaft Side/Shaft End
<b>PARAMETER</b>				
Rated Voltage(Vdc)	36	36	36	36
Rated Power (W)	250	250	200	250
Rated Speed(Rpm)	225-325	225-365	325-380	200-325
Maximum Torque(N.m)	35	40	28	40
Weight (kg)	1.8	2.1	2	2.8
Efficiency (%)	≥ 80	≥ 80	≥ 80	≥ 80
<b>FUNCTION</b>				
Integrated Torque	-	Optional	Optional	Optional
Power Off Brake	Optional	Optional	Optional	Optional
Handlebar Throttle	-	-	-	-
Lights Voltage (V/W)	-	-	-	-
Walk Assist Function	Optional	Optional	Optional	Optional
Noise (dB)	< 55	< 55	< 55	< 55
IP Level	IPX5	IPX5	IPX5	IPX5
Operating Temperature (°C)	-20-55	-20-55	-20-55	-20-55



TRUCKRUN's products have passed EN15194, ROHS, CE and UL tests and certifications.

# HUB MOTOR



**RW06**

**RW05-L**

**RW12**

**RW11**

<b>POSITION</b>	Rear	Rear	Rear	Rear
<b>SUITABLE MODEL</b>	Trekking/MTB	Trekking/MTB	City/MTB	Fat-tire
<b>DIMENSION</b>				
Integrated wheel	Optional	-	-	Optional
A (mm)	40.8	40.8	40.8	68
B (mm)	φ158.8	φ158.8	φ158.8	φ158.5
C (mm)	φ44	φ44	-	φ44
D (mm)	15.25	15.25	24	15.25
E (mm)	38.3	39.2	39	39.5
OLD (mm)	100/135	140	145-160	135/175/185/190
Wheel diameter (Inch)	20-29	20-29		20-29
Installation mode	Screwed	Cassette	Screwed	Cassette/Screwed
Spoke size	12G-13G/36H	12G-13G/36H	12G-13G/36H	36H*13G(12G)
Cabling Route	Shaft End	Shaft End	Shaft End	Shaft End
<b>PARAMETER</b>				
Rated voltage(Vdc)	36/48	36/48	36/48	48
Rated power (W)	350/500	350/500	350/500	350/500/750
Rated speed(Rpm)	225-420	225-420	240-480	240-480
Maximum torque(N.m)	50	50	50	80
Weight (kg)	3.4	3.5	3.4	3.8
Efficiency (%)	≥ 80	≥ 80	≥ 80	≥ 80
<b>Function</b>				
Integrated Torque	-	Optional	Optional	Optional
Power off brake	Optional	Optional	Optional	Optional
Handlebar throttle	Optional	Optional	Optional	Optional
Lights voltage (V/W)	-	-	-	-
Walk Assist Function	Optional	Optional	Optional	Optional
Noise (dB)	< 55	< 55	< 55	< 55
IP Level	IPX5	IPX5	IPX5	IPX5
Operating Temperature (°C)	-20-55	-20-55	-20-55	-20-55



TRUCKRUN's products have passed EN15194, ROHS, CE and UL tests and certifications.

# HUB MOTOR



RW11-20Z



RW06-20Z



RW28



RW29

POSITION	Rear	Rear	Rear	Rear
SUITABLE MODEL	Fat-tire	City/MTB	MTB	Fat-tire
DIMENSION				
Dimension diagram				
Integrated wheel	Yes	Yes	-	-
A (mm)	74.3	25	38.5	65
B (mm)	φ420	φ420	φ192.4	φ191.2
C (mm)	φ44	φ44	φ44	φ44
D (mm)	15.25	15.25	15.25	15.25
E (mm)	41.45	39.8	38	39.5
OLD (mm)	175	137	100/138	135/175/185/190
Wheel diameter (Inch)	-	-	20-29	20-29
Installation mode	Cassette/Screwed	Cassette/Screwed	All Fit	Cassette/Screwed
Spoke size	-	-	12G-13G/36H	36H*13G(12G)
Cabling Route	Shaft End	Shaft End	Shaft Side	Shaft Side
PARAMETER				
Rated voltage(Vdc)	48	36/48	48	48
Rated power (W)	500/750	350/500	750	1000/1200/1500
Rated speed(Rpm)	240-480	225-420	345-520	320-680
Maximum torque(N.m)	65-80	50	70	90
Weight (kg)	5.6	4.6	4.2	5.6
Efficiency (%)	≥ 80	≥ 80	≥ 80	≥ 80
Function				
Integrated Torque	-	Optional	Optional	Optional
Power off brake	Optional	Optional	Optional	Optional
Handlebar throttle	Optional	Optional	Optional	Optional
Lights voltage (V/W)	-	-	-	-
Walk Assist Function	Optional	Optional	Optional	Optional
Noise (dB)	< 55	< 55	< 55	< 55
IP Level	IPX5	IPX5	IPX5	IPX5
Operating Temperature (°C)	-20-55	-20-55	-20-55	-20-55



TRUCKRUN's products have passed EN15194, ROHS, CE and UL tests and certifications.

# ELECTRIC SCOOTER MOTOR



**FZ01**



**FZ02**



**RZ05**

SUITABLE MODEL	8' E-Scooter	10' E-Scooter	12' E-Scooter
<b>DIMENSION</b>			
Integrated wheel	-	-	-
A (mm)	-	-	-
B (mm)	-	-	-
C (mm)	-	-	-
D (mm)	-	-	-
E (mm)	-	-	-
OLD (mm)	76	90.5	130
Wheel diameter (Inch)	-	-	-
Installation mode	-	-	-
Spoke size	-	-	-
Cabling Route	Shaft End	Shaft Side	Shaft End
<b>DETAILED PARAMETER</b>			
Rated voltage(Vdc)	36	36/48	36/48
Rated power (W)	250/350	350/500	350
Rated speed(Rpm)	680-820	680-820	680-820
Maximum torque(N.m)	20	20	25
Weight (kg)	3.3	3.5	3.5
Efficiency (%)	≥ 80	≥ 80	≥ 80
<b>FUNCTION</b>			
Integrated Torque	-	-	-
Power off brake	Optional	Optional	Optional
Handlebar throttle	Optional	Optional	Optional
Lights voltage (V/W)	-	-	-
Walk Assist Function	-	-	-
Noise (dB)	< 55	< 55	< 55
IP Level	IPX5	IPX5	IPX5
Operating temperature (°C)	-20 ~ 55	-20 ~ 55	-20 ~ 55



TRUCKRUN's products have passed EN15194, ROHS, CE and UL tests and certifications.

# ELECTRIC MOTORCYCLE MOTOR: M30

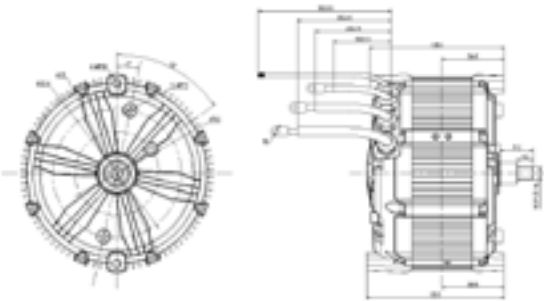

## M30

Suitable model	Sand/Jungle/Snow/Beach
Rated power (W)	3000-6000
Rated voltage(Vdc)	60-72
Efficiency (%)	≥ 80%
Rated speed(Rpm)	5000-7500
Maximum torque(N.m)	30-60
Stator insulation class	Class F
Noise (dB)	< 55
IP Level	IP65
Operating temperature (°C)	-20 ~ 45

# DUAL DRIVE & DUAL BATTERY SYSTEM



## Safety

Single battery discharge automatic switching.  
Low voltage protection function.



## Increase mileage

Low power consumption, long-term durability.



A	88mm
B	45mm
C	18mm

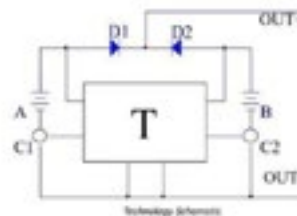

TRUCKRUN's products have passed EN15194, ROHS, CE and UL tests and certifications.

# CONTROLLER



**CS601A (UART)  
XCS601A(CAN)**



**CT602(UART)  
XCT602(CAN)**



**CD901(UART)  
XCD901(CAN)**

<b>DIMENSION</b>			
Dimension diagram			
A (mm)	85	166	130
B (mm)	53	33	62
C (mm)	30	31	65
<b>GENERAL PARAMETERS</b>			
Rated voltage(Vdc)	24/36/48	36/48	48/52/60
Current limiting value (A)	18/15/14	15/13	22*2
Undervoltage value(DCV)	20/31/40	31/40	31/40/45
Rated current (A)	9/7/7	7/6	11*2
Rated power (W)	250~350	250	(500/750/1000/1500)*2
Weight(g)	222	290	930
<b>FUNCTION</b>			
Control type	Sine	Sine	Sine
Brake type	Low level	Low level	Low level
PAS Mode	Speed / Speed + Torque	Speed / Speed + Torque	Speed / Speed + Torque
Speed regulating voltage (V)	1.1~3.9	1.1~3.9	1.1~3.9
Support mode	0~9	0~9	0~9
Walk-Assit (km/h)	6	6	6
Lamp module (DCV/W)	6/3(max)36/18(max)	6/3(max)36/18(max)	6/3(max)36/18(max)
IP Level	IPX5	IPX5	IPX5
Operating temperature (°C )	-20~55	-20~55	-20~55



TRUCKRUN's products have passed EN15194, ROHS, CE and UL tests and certifications.



# SENSOR



PS.S06



PS.SW03



PS.BS01



PS.ST06

DIMENSION				
Dimension diagram				
A (mm)	52	47	61	148
B (mm)	φ45	34	18	38.6
C (mm)	φ16	14	11	68
D(mm)	-	-	-	39.8
E (mm)	-	-	-	41.4
F(mm)	-	-	-	2- φ44mm
G(mm)	-	-	-	2- BC1.37" *24T
GENERAL PARAMETERS				
Input voltage (DCV)	4.2~5.5	4.2~5.5	4.0~5.5	4.5~5.5
Signal(Pulses/Cycle)	12/24	1	-	36/32
Installation location	Central axis	Rear Fork	-	Bottom bracket
Sensing distance (mm)	-	5~25	-	-
Output power (W)	-	< 0.3	-	-
Output signal	High level	-	Hole Output	0.74-3.3V
Output impedance (Ω)	-	-	100±2	-
Switch time (S)	-	-	0.2( Adjustable )	-
PAS Mode	Speed	-	-	Speed / Speed + Torque
Shaft Standard	-	-	-	JIS/ISIS
Signal Sensitivity((mV/N.m)	-	-	-	35
BB Width(mm)	-	-	-	68/73/84/100/120
Duty Cycle Of Speed Signal (%)	-	-	-	40-60
Measuring Range(N.m)	-	-	-	0.5-80
FUNCTION				
IP Level	IPX5	IPX5	IPX5	IPX5
Operating temperature (°C )	-20~55	-20~55	-20~55	-20~55

# ■ DISPLAY



**E03(UART)  
XE03(CAN)**



**CC01-X(UART)**



**CB03(UART)  
XCB03(CAN)**



**CC03(UART)  
XCC03(CAN)**

PROTOCOL	UART/CAN	UART	UART/CAN	UART/CAN
<b>DETAILED PARAMETERS</b>				
Rated voltage(Vdc)	36/48/60	36/48/60	36/48/60	36/48/60
Display Type	LED	TFT	LCD	TFT
Support Modes	0-3/0-5/0-9	0-3/0-5/0-9	0-3/0-5/0-9	0-3/0-5/0-9
Mounting dimension	φ22.2	φ22.2/φ25.4/φ31.8	φ22.2	φ22.2/φ25.4/φ31.8
<b>FUNCTION</b>				
TRUCKRUN IOT Solution	YES	-	-	YES
OTA	YES	-	-	YES
Bluetooth	YES	-	-	YES
Light Sensor	YES	YES	-	YES
USB Charge	-	YES	-	YES
Real-time speed	YES	YES	YES	YES
Maximum speed	-	YES	-	YES
Average speed	-	YES	-	YES
Single mileage	-	YES	YES	YES
Total mileage	-	YES	YES	YES
Remaining mileage	-	-	YES	YES
Battery power display	YES	YES	YES	YES
Error code	YES	YES	YES	YES
Power display	-	YES	-	YES
Real-time current	-	YES	-	YES
Metric /Imperial	YES	YES	YES	YES
Walk-Assit function	YES	YES	YES	YES
Noise (dB)	< 55	< 55	< 60	< 60
IP Level	IPX5	IPX5	IPX5	IPX5
Operating Temperature (°C)	-20~55	-20~55	-20~55	-20~55



TRUCKRUN's products have passed EN15194, ROHS, CE and UL tests and certifications.

# Establish a closer connection with us!

Welcome to visit our official website [truckrun-e.com](http://truckrun-e.com) and social media



[truckrun-e.com/help](http://truckrun-e.com/help)

## Need any help?

For sustainable development, we have simplified the printed materials, but you can download a more detailed electronic version of the manual through the TRUCKRUN Help Center! Additionally, we have established separate communication channels for both riders and manufacturers.

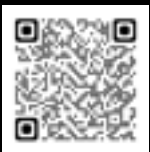

[truckrun-e.com/contact](http://truckrun-e.com/contact)

## Be our partner!

We have cooperated with dozens of ebike companies around the world to jointly create efficient, environmentally friendly and stylish ebikes. Welcome to our official website to contact us! TRUCKRUN looks forward to cooperating with you!



[truckrun-e.com/ebike-blog/Videos](http://truckrun-e.com/ebike-blog/Videos)

## Watch videos to see others' reviews of TRUCKRUN

We have gathered videos on YouTube about TRUCKRUN motors, which are provided by media or ebike manufacturers. These videos offer you authentic riding experiences and actual motor performance evaluations.



[truckrun-e.com/mid-drive-motors](http://truckrun-e.com/mid-drive-motors)

## Learn more about the products...

Want to know more about the product? You can screen and compare the parameters of different motors on the official website of TRUCKRUN. We also provide product manuals for you to download, so that you can fully understand product information.

## Follow us on the social media!

Our social media accounts not only provide continuous updates on product developments and exhibition news but also feature media review videos, factory tour videos, industry insights articles, and more. We look forward to engaging in friendly interactions with your social media accounts!



# TRUCKRUN



Complete Manual

Website: [www.TRUCKRUN-e.com](http://www.TRUCKRUN-e.com)

Order inquiries: [salesman@TRUCKRUN-e.com](mailto:salesman@TRUCKRUN-e.com)

Technology & Service: [support@TRUCKRUN-e.com](mailto:support@TRUCKRUN-e.com)

Market cooperation: [marketing@TRUCKRUN-e.com](mailto:marketing@TRUCKRUN-e.com)

Address: Building 5, No.9, Xinqin Road, Xinwu District, Wuxi City, Jiangsu Province

©September 2023 Wuxi TRUCKRUN Motor Co.,Ltd.

